

Auto Chisellers

- Multi-purpose tools with a wide range of chisels.
- Good use for narrow spaces.
- Widely used for automobile repair and sheet metal work.



NBH-400
(External Power Regulator,
Retainer Spring)



NBH-600A
(Built-in Power Regulator,
Retainer Spring)

*Chisel not included.

Model	Code	Capacity				Blow per minute	Piston diameter		Piston stroke		Overall length		Mass		Air inlet thread	Hose size		Average air consumption	
		Duralumin		Steel			mm	in	mm	in	mm	in	kg	lb		mm	in	m ³ /min	ft ³ /min
		mm	in	mm	in														
NBH-400	30070	6.4	1/4	4.8	3/16	1600	13	1/2	95	3 ³ / ₄	217	8 ⁹ / ₁₆	1.4	3.1	1/4	9.5	3/8	0.11	3.9
NBH-600A	30072	8	5/16	6.4	1/4	1500	19	3/4	68	2 ¹¹ / ₁₆	228	9	4.4	1/4	9.5	3/8	0.16	5.7	

Needle Scaler Attachment for NBH-600A

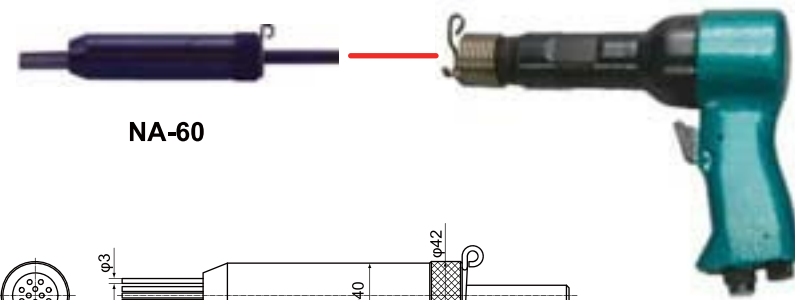



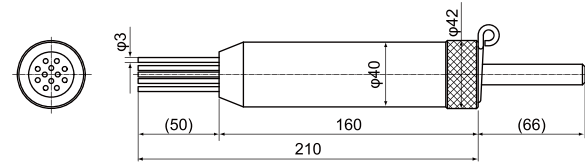



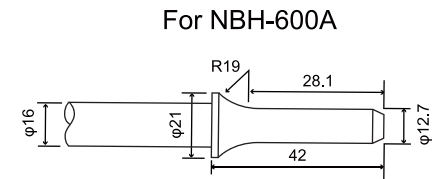
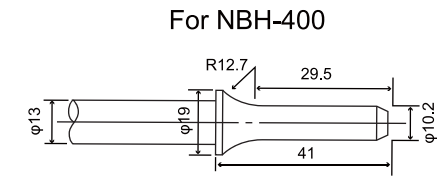

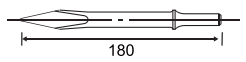

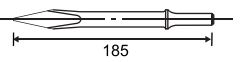
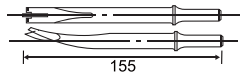

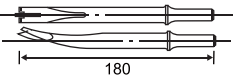
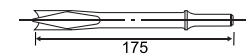

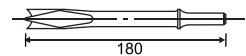
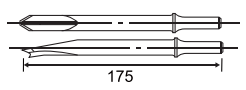

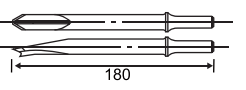

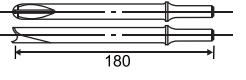
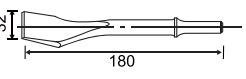

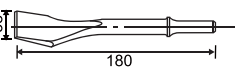
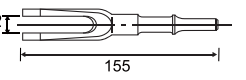

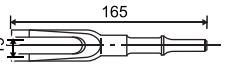
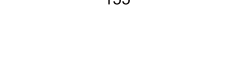

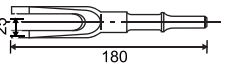
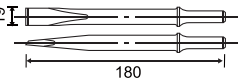
NA-60

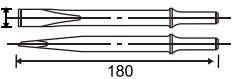
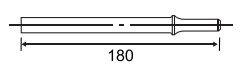

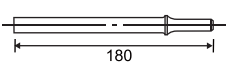
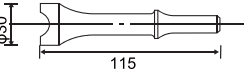
Chisels for Auto Chisellers

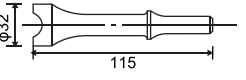
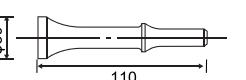

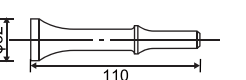
Dimension	Code No.	Shape	Dimension	Code No.
	Demolition Point Chisel 17500220			Demolition Point Chisel 17500510
	Panel Cutter 17500110			Panel Cutter 17500400
	Sheet Metal Cutter 17500120			Sheet Metal Cutter 17500410
	Muffler Cutter 17500130			Muffler Cutter 17500420
	Bushing Remover 17500140			Bushing Remover 17500430
	Paint Scraper 17500150			Paint Scraper 17500440
	Fork Chisel 17500200			Fork Chisel Width 19mm 17500450
	Fork Chisel 17500200			Fork Chisel Width 25mm 17500460
	Flat Chisel 17500190			Flat Chisel 17500500
	Straight Punch 17500160			Straight Punch 17500470
	Tie Rod Tool 17500170			Tie Rod Tool 17500480
	Smoothing Tool 17500180			Smoothing Tool 17500490